

Warning: Please cut off the electric before the installation.

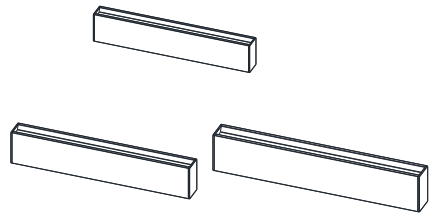

PRODUCT FEATURES:

1. The simple structure, small size, friendly Installation.
2. No noise, No Glare, High CRI, High transmittance.
3. Energy saving, Eco-Friendly, 50000H Lifespan, Wide applicability.

CAUTIONS:

- The luminaries should be installed, connected and tested by a qualified electrician, Do not use in direct sunlight, moist, shock, rain or corrosive gas condition, Avoid causing the lamp to fall and electric leakage.
- Please power off the electric and ensure the cable won't be damaged before the luminaries installation or maintenance.
- The light cannot be covered by insulating layer or similar materials.
- The luminaries working environment temperature too high or too low all will compact the lifespan, When cleaning the lamps, please use a soft cloth and soapy water to wring and wipe, Please do not wipe with volatile materials such as thinner and gasoline, to prevent discoloration, The surface of the lamp should be maintained regularly.
- please do not transform luminaries structure and mode of the wire connection at will, avoid electric shock or fire, When the lamp is abnormal, please cut off the power quickly.
- Improper use of lamps or random replacement of non-original accessories will not guarantee its warranty period, and manufacturers are free to change designs, specifications and assembly instructions.

WARNING:

The light and Driver cannot install on the combustible surface, and the place where has explosive gas, liquid, dust.



1

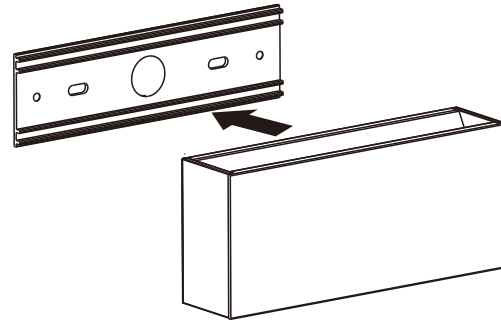

2

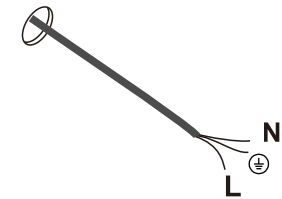

3

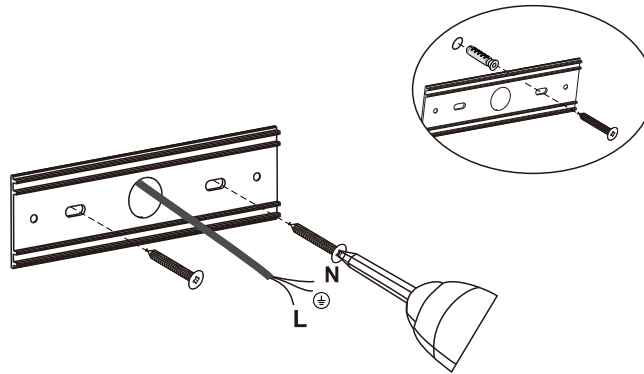

4

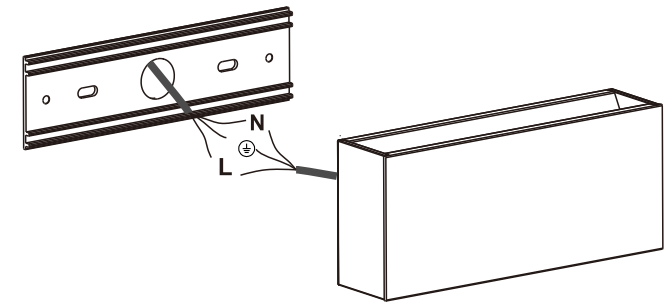

5

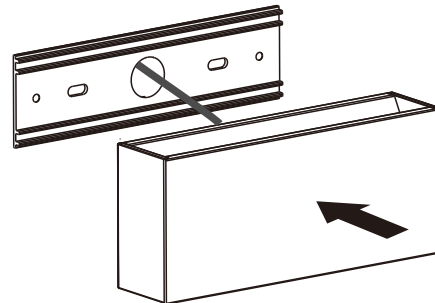

6

